

Finals Results

Shawn Fleming Central State University	118 lbs dec. 12-2 over	Jeffery Wright Carson-Newman College
Troy Humphrey Western Montana College	126 lbs. dec. 14-0 over	Torey McCully Alaska Pacific University
Ken Wharry Southern Oregon State Univ	134 lbs. dec. 5-4 over	Craig Roberts Simon Fraser University
Chuck Ahsmuhs Pacific University	142 lbs. dec. OT 2-1 over	Todd Steidley Central State University
Ed Sernowski Simon Fraser University	150 lbs. dec. 12-5 over	Kevin Freeman Central State University
Johnny Nimmo Central State University	158 lbs. dec. 5-2 over	Bill McDonald Southwest State University
Chuck Pipher U. of Southern Colorado	167 lbs. dec. 12-2 over	Gianni Buono Simon Fraser University
John Fredrickson Alaska Pacific University	177 lbs. dec. OT 3-1 over	Hugh Meek Carson-Newman College
Bob Manville Olivet Nazarene University	190 lbs. dec. 11-8 over	Scott Pickert Mesa College
Dan Payne Simon Fraser University	275 lbs. dec. 5-2 over	Jim Williamson U. of Minnesota-Morris

Awards

Outstanding Wrestler for 1988 - Chuck Pipher, U. of Southern Colorado

Coach of the Year for 1988 - Mike Jones, Simon Fraser University

Gorriaran Trophy for 1988 - Chuck Pipher, U. of Southern Colorado
Greatest number of Falls
in the least total time

31st NAIA Wrestling Championships

March 3, 4, 5, 1988 Pacific Lutheran University Tacoma, Washington

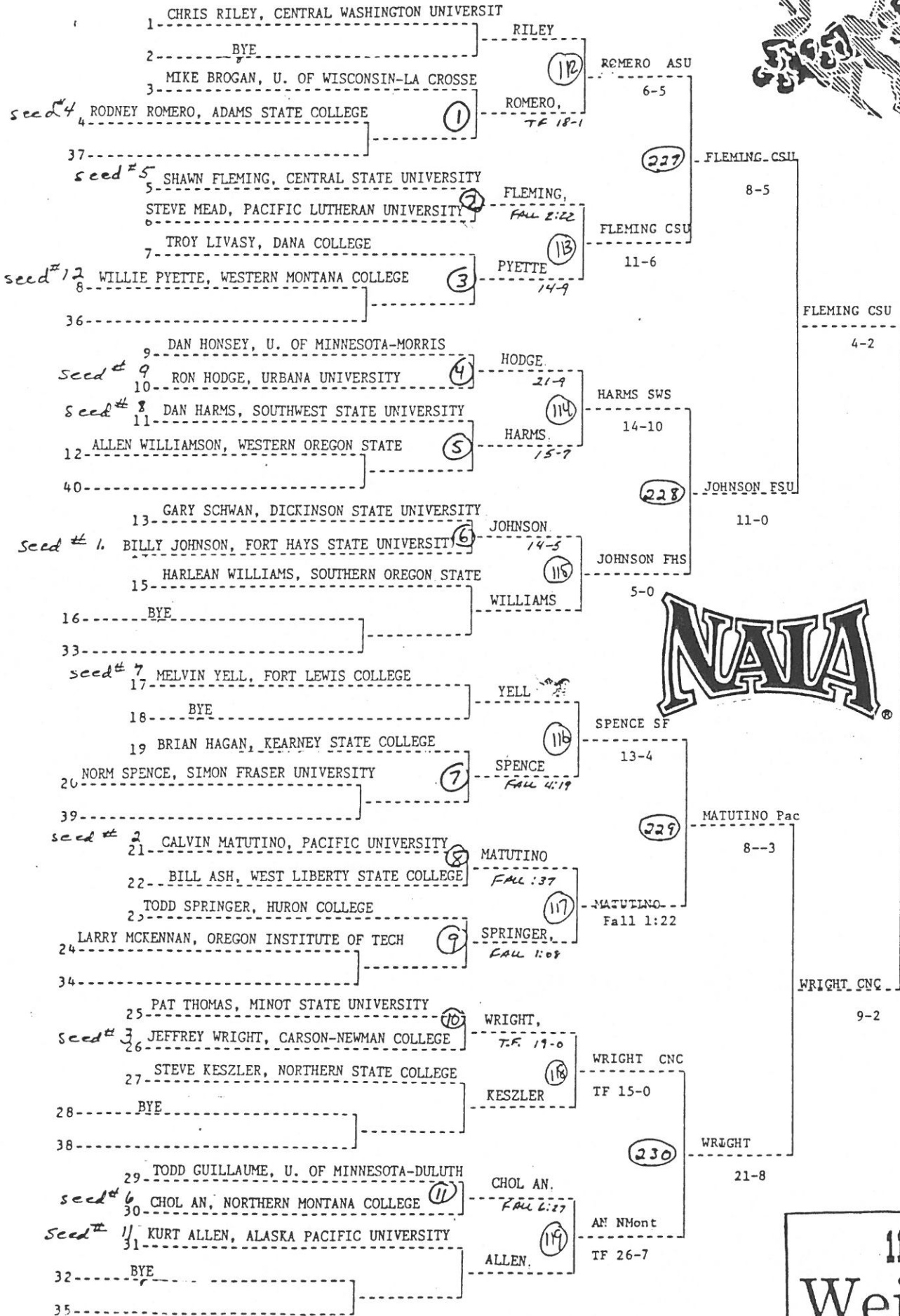

Champion

118
Weight

31st NAIA

Wrestling Championships

Pacific Lutheran University Tacoma, Washington

BYE

BROGAN UWL

MIKE BROGAN

(231)

ALLEN APU

Fall 3:20

STEVE MEAD

ALLEN APU

(120)

MEAD PLU

341

ALLEN APU

TROY LIVASY

(232)

KESZLER NSTAT

9-8

TF 18-0

HARMS SWS

DAN HONSEY

(121)

WILLIAMSON WOS

HARMS SWS

8-7

ALLEN WILLIAMSON

(233)

SPRINGER H

WBD

342

YELL FLC

ROMERO ASC

8-1

GARY SCHWAN

SCHWAN DSU

BYE

(234)

YELL FLC

12-7

Fall 2:42

ROMERO ASC

Calvin

MATUTINO Pac

BYE

ROMERO ASC

6-4

13-4

BRIAN HAGAN

HAGAN K

(235)

HAGAN K

13-11

MATUTINO Pac

BILL ASH

WILLIAMS SORE

(122)

ASH WL1B

349

HAGAN K

LARRY MCKENNAN

(236)

HODGE URB

6-3

9-3

AN NMont

MATUTINO Pac

PAT THOMAS

THOMAS MINOT

BYE

237

THOMAS Minot

23-21

CHOL AN NMont

9-6

3rd

TODD GUILLAUME

PYETTE WMC

344

THOMAS Minot

CHOL AN NMont

10-5

BYE

GUILLAUME UMD

(238)

RILEY CWU

GUILLAUME UMD

11-1

SPENCE SF

Bill

JOHNSON FHS

SPENCE SF

5-3

7-5

JOHNSON FHS

Redney

ROMERO ASC

ROMERO ASC

CHOL AN NMont

5th

9-2

HARMS SWS

SPENCE SF

SPENCE SF

7th

7-1



31st NAIA Wrestling Championships

March 3, 4, 5, 1988 Pacific Lutheran University Tacoma, Washington

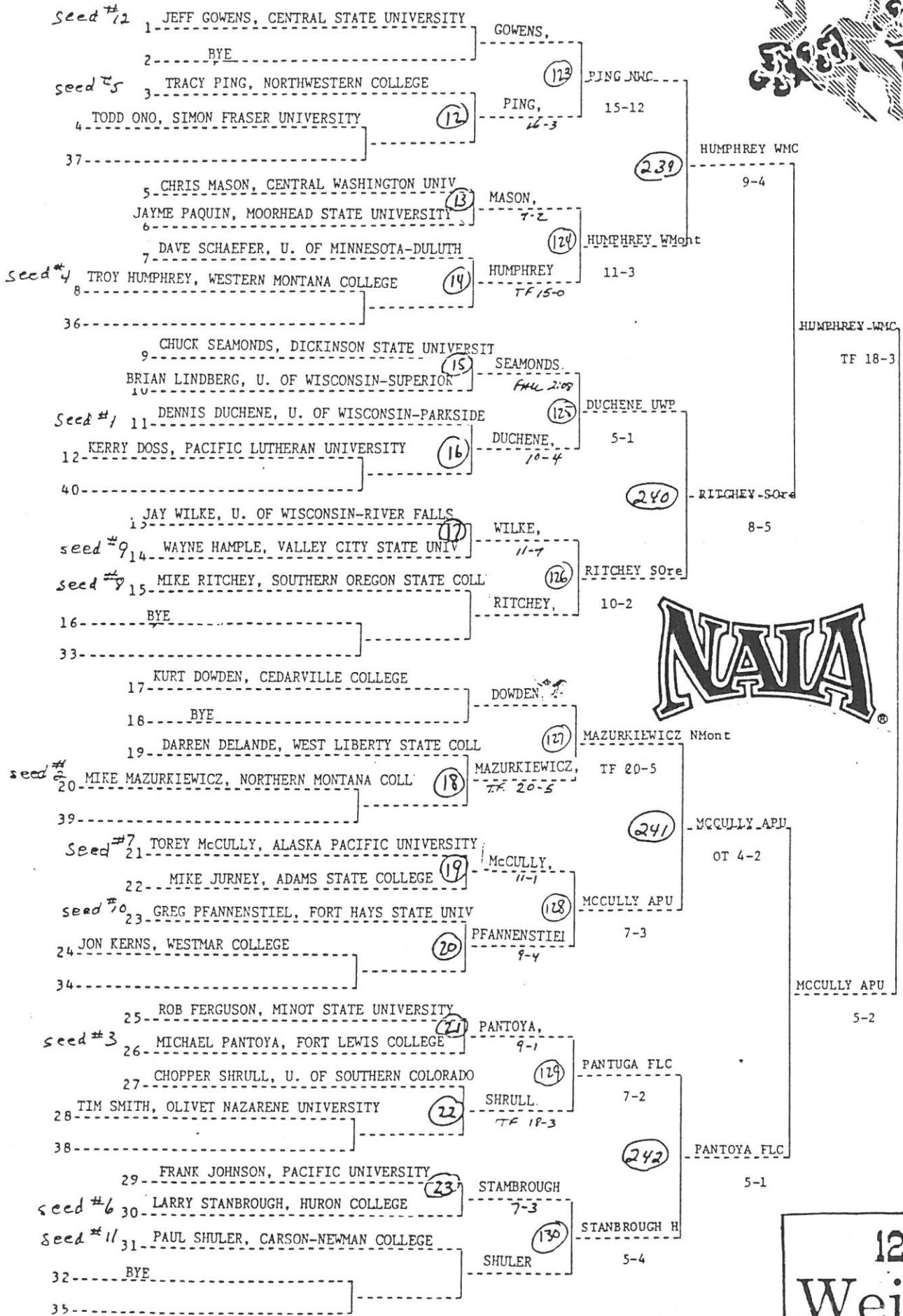

Champion

126
Weight

31st NAIA Wrestling Championships

Pacific Lutheran University Tacoma, Washington

BYE

ONO SF

TODD ONO, (243) SCHULER CNC

JAYME PAQUIN, (131) PAQUIN Moor 9-4

DAVE SCHAEFER, (244) SCHRULL USC 14-6

BRIAN LINDBERG, SCHRULL USC Fall 1:40

KERRY DOSS (132) DOSS PLU DUCHENE UWP 9-4

WAYNE HAMPLE, (245) PFANNENSTIEL FHS PING NWC

BYE HAMPLE Valley 346 PFANNENSTIEL FHS Fall 5:28

BYE (246) HAMPLE Valley 17-6 PING NWC

BYE DOWDEN CC 9-4 PING NWC 12-5

DARREN DELANDE, DELANDE WLib PANTOYA FLC 4-3

MIKE JURNEY, (247) WILKE UWR PANTOYA FLC

JON KERNS, (133) JURNEY ASC 12-5 WILKE UWR 347

ROB FERGUSON, (248) SEAMONS DSU 17-3 MAZURKIEWICZ NMC

TIM SMITH, (134) FERGUSON Minot STANBROUGH H 10-3

FRANK JOHNSON, (249) MASON CWU MAZURKIEWICZ NMont

BYE JOHNSON Pac 348 GOWENS CSU 7-3

GOWENS CSU 9-8 MAZURKIEWICZ NMont

MAZURKIEWICZ NMont 8-6 MAZURKIEWICZ NMont 5-2

RITCHIE Sore

Tracy PING NWC

Mike RITCHIE Sore

RITCHIE Sore 5th Fall 1:20

SCHRULL USC

STANBROUGH H

STANBROUGH H 7th 13-4



126

Consolation Bracket

31st NAIA Wrestling Championships

March 3, 4, 5, 1988 Pacific Lutheran University Tacoma, Washington



seed #5	1 JAMES JENKINS, WAYNESBURG COLLEGE	JENKINS,		
	2 BYE			
seed #12	3 TODD DOWDEN, CEDARVILLE COLLEGE	DOWDEN,	(135)	JENKINS Wayne
	4 JEFF EVENHOUSE, NORTHWESTERN COLLEGE		(24)	Fall 6:50
	37		7-4	
	5 JOHN GODINHO, PACIFIC LUTHERAN UNIVERSITY			(251) WHARRY Sore
	6 DAN VAN HOOSE, WESTERN STATE COLLEGE	VAN HOOSE,	(25)	19-7
	7 KEN WHARRY, SOUTHERN OREGON STATE COLLEGE	WHARRY,	(136)	OT: 3-1
seed #4	8 CAL STUKEL, HURON COLLEGE		(26)	WHARRY Sore
	36			Fall 2:39
	9 JON LARCHICK, KEARNEY STATE COLLEGE			
seed #9	10 JIM GONTIS, ADAMS STATE COLLEGE	GONTIS,	(27)	WHARRY Sore
	11 BLAINE NOVAK, U. OF MINNESOTA-MORRIS		(137)	8-1
seed #8	12 JEFF WALLACE, ALASKA PACIFIC UNIVERSITY	WALLACE,	(28)	WALLACE APU
	40			4-2
seed #1	13 JEFF DRAVIS, U. OF MINNESOTA-DULUTH	DRAVIS,	(29)	(252) WALLACE APU
	14 MIKE WILPOLT, MESA COLLEGE		(138)	7-1
	15 PHILIP ANDERSON, WESTERN OREGON STATE COL	ANDERSON,		DRAVIS UMD
	16 BYE			INJ DEF
	33			
seed #2	17 JACK DANNER, U. OF WISCONSIN-PARKSIDE	DANNER,	(139)	DANNER UMD
	18 BYE			8-5
	19 LARRY RATHER, U. OF WISCONSIN-SUPERIOR			
	20 WEST HARDING, FORT HAYS STATE UNIVERSITY	HARDING,	(30)	(253) CLARK NStat
	39			9-5
	21 SCOTT RUSSELL, DICKINSON STATE UNIVERSITY			
seed #7	22 JIMMY FILIPPO, CENTRAL STATE UNIVERSITY	FILIPPO,	(31)	CLARK NStat
seed #10	23 EDDIE CLARK, NORTHERN STATE COLLEGE	CLARK,	(140)	14-13
	24 KEVIN BYRD, OLIVET NAZARENE UNIVERSITY		(32)	
	34			ROBERTS SF
	25 CHUCK CALHOUN, PACIFIC UNIVERSITY	CALHOUN,	(33)	OT 4-1
	26 VINNIE MONSEAU, WEST LIBERTY STATE COLL			
seed #3	27 CRAIG ROBERTS, SIMON FRASER UNIVERSITY	ROBERTS,	(141)	ROBERTS SF
	28 PAUL CORNER, U. OF WISCONSIN-LA CROSSE		(34)	Fall 4:50
	38			
	29 ROBERT OVERTURF, FORT LEWIS COLLEGE		(35)	(254) ROBERTS SF
seed #6	30 RYAN MAPSTON, WESTERN MONTANA COLLEGE	MAPSTON,	(142)	7-3
seed #11	31 WARREN DUMAS, PEMBROKE STATE UNIVERSITY	DUMAS,	(143)	
	32 BYE			
	35			3-2



Champion

134
Weight

31st NAIA Wrestling Championships

Pacific Lutheran University Tacoma, Washington

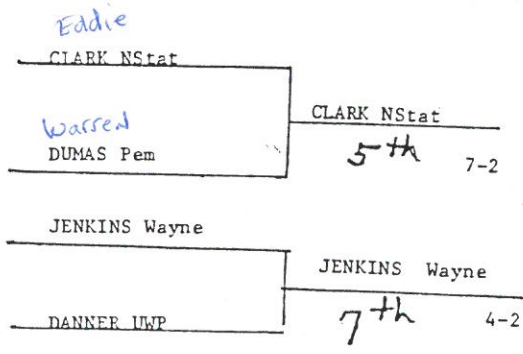
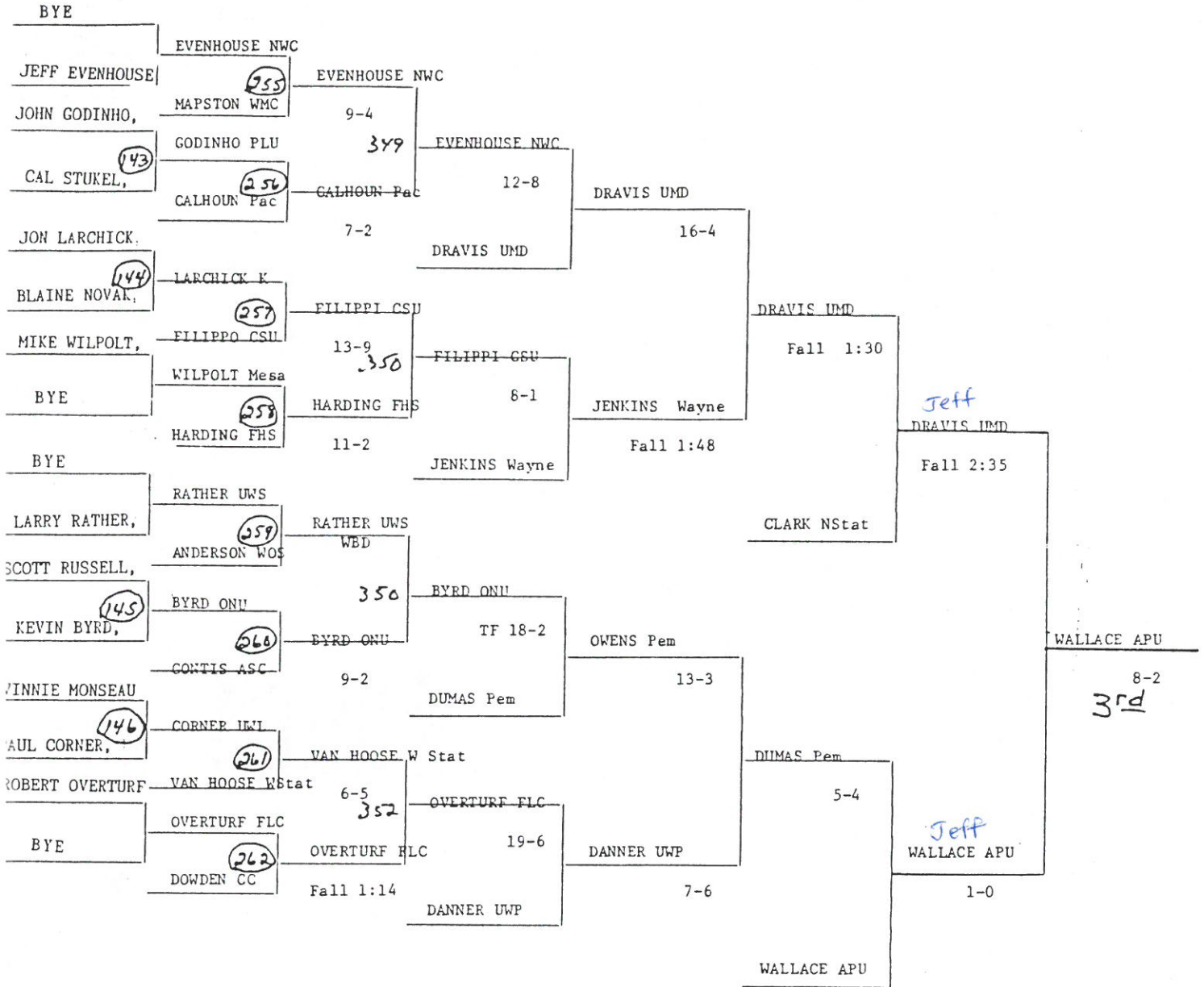

134
Consolation Bracket

31st NAIA Wrestling Championships

March 3, 4, 5, 1988 Pacific Lutheran University Tacoma, Washington

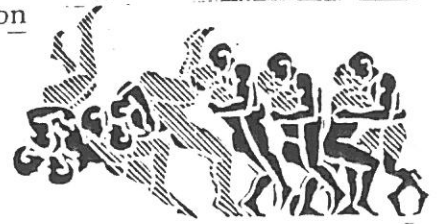

Seed	Name	Team	Weight	Record	Notes
1	SEAN CARLSON	SOUTHERN OREGON STATE COLL			
2	BYE				
3	JEFF KLOETZER	NORTHERN MONTANA COLLEGE	177	9-7	KLOETZER NMont
4	CLIFF NOCE	FORT HAYS STATE UNIVERSITY	36	4-2	
5	RANDY DORN	SOUTHWEST STATE UNIVERSITY	37	6-5	JENKINS Wayne
6	MARK SHUDA	U. OF WISCONSIN-LA CROSSE	148	11-1	JENKINS Wayne
7	MARK JENKINS	WAYNESBURG COLLEGE	148	11-1	JENKINS Wayne
8	BRIAN CHINSKI	OLIVET NAZARENE UNIVERSITY	38	FALL 6:09	
9	ROBERTO FURTADO	U. OF SOUTHERN COLORADO	37	10-9	STEIDLEY CSU
10	JEFF WEBER	DICKINSON STATE UNIVERSITY	49	18-7	LONDGREN UMD
11	TREVOR LONDGREN	U. OF MINNESOTA-DULUTH	49	14-4	LONDGREN UMD
12	JOHN FORD	WESTERN STATE COLLEGE	40	7-5	STEIDLEY CSU
13	CHRIS FUOCO	SIMON FRASER UNIVERSITY	51	8-2	STEIDLEY CSU
14	DAVE MORTENSON	MINOT STATE UNIVERSITY	7F 18-3		
15	TODD STEIDLEY	CENTRAL STATE UNIVERSITY	150	18-6	STEIDLEY CSU
16	JOHN KARL	U. OF WISCONSIN-PARKSIDE	42		
17	CAREY JOHNSON	PACIFIC LUTHERAN UNIV	43		
18	GREG KAY	U. OF WISCONSIN-RIVER FALLS	151	20-7	KAY UWR
19	TAD THORSTENSON	WESTERN MONTANA COLLEGE	151	7-4	THORSTENSON
20	DARRELL BULLINGTON	CHADRON STATE COLLEGE	44		
21	JOHN KLEMPA	WEST LIBERTY STATE COLLEGE	45	OT 2-1	KAY UWR
22	JIM LABROSSE	ADAMS STATE COLLEGE	152	15-1	LABROSSE ASC
23	JESS ROBINS	WESTMAR COLLEGE	152		
24	ROGER LOVETT	WILMINGTON COLLEGE	46	FALL 1:45	
25	TONY OWENS	CARSON-NEWMAN COLLEGE	47	6-1	AHSMUHS Pac
26	CHUCK AHSMUHS	PACIFIC UNIVERSITY	153	16-4	AHSMUHS Pac
27	ROB GRUMLEY	MESA COLLEGE	48	15-14	STEVENSON
28	SANDY STEVENSON	CENTRAL WASHINGTON UNIV	48		
29	ROY HEVERLY	PEMBROKE STATE UNIVERSITY	154	3-2	HEVERLY Pem
30	PHIL CRUZ	CEDARVILLE COLLEGE	49	12-2	
31	TOM WORST	ALASKA PACIFIC UNIVERSITY	154	Fall :07	WORST
32	BYE				
33					
34					
35					



Champion

142
Weight

31st NAIA Wrestling Championships

Pacific Lutheran University Tacoma, Washington

BYE

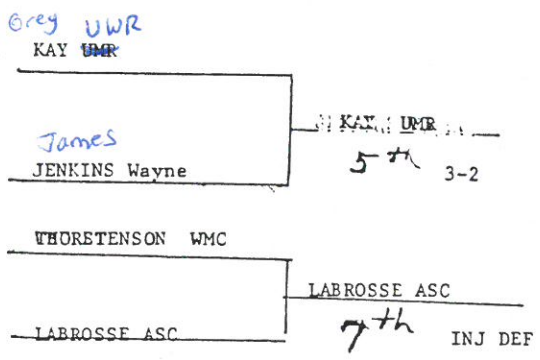
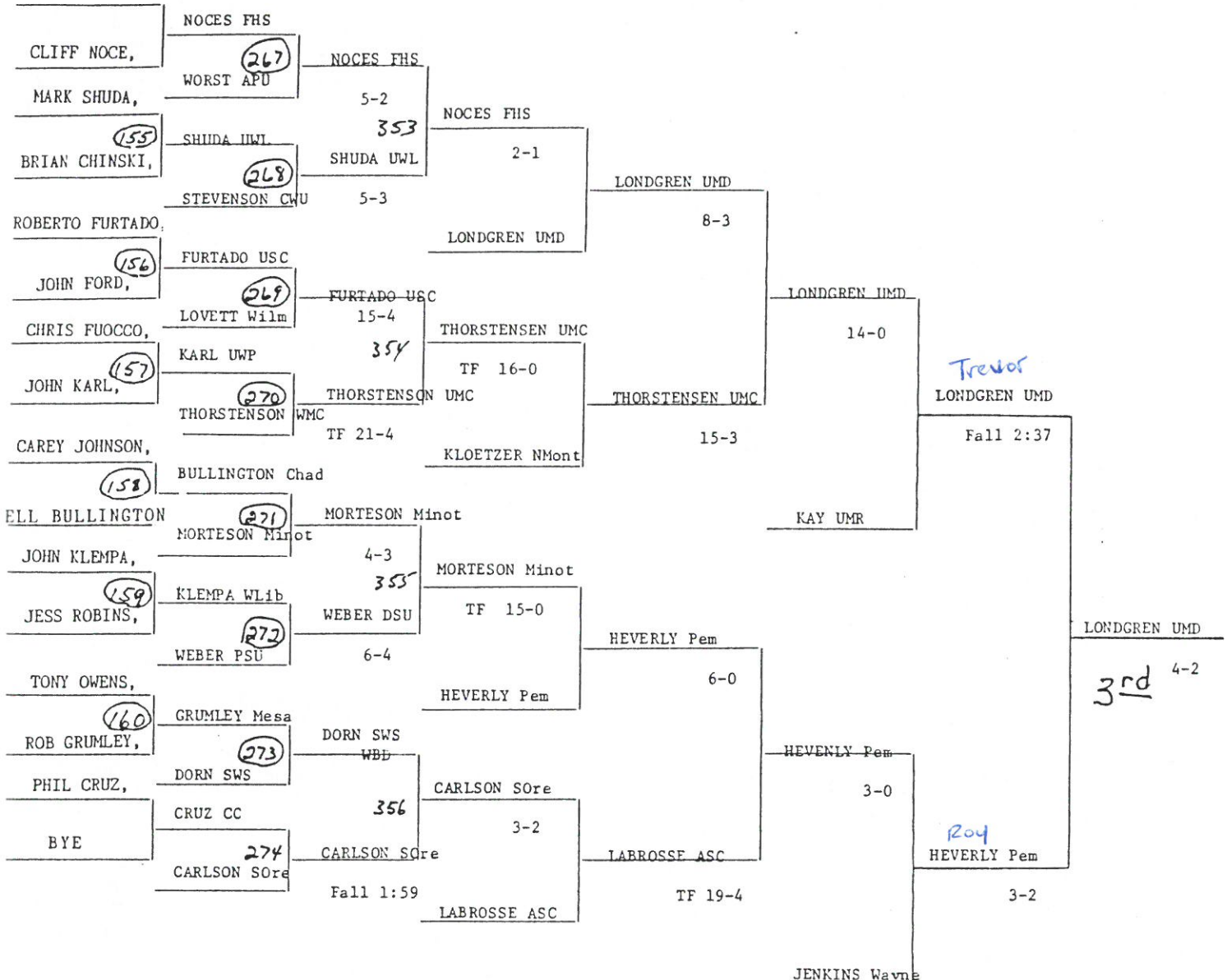

142

Consolation Bracket

31st NAIA Wrestling Championships

March 3, 4, 5, 1988 Pacific Lutheran University Tacoma, Washington



1	PETE FRANKLIN, U. OF WISCONSIN-RIVER FALLS	FRANKLIN,		
2	BYE			
seed #4	EDDIE CROCKER, CARSON-NEWMAN COLLEGE	(61) CROCKER,	5-3	
4	KEVIN KNIGHT, ALASKA PACIFIC UNIVERSITY	(50) CROCKER,	11-1	
37				(275) ZEIGLER USC
5	KEVIUS HODGES, HURON COLLEGE			Fall 6:46
seed #5	JIM ZEIGLER, U. OF SOUTHERN COLORADO	(51) ZEIGLER,	8-2	
6	LARRY EVENS, ADAMS STATE COLLEGE	(162) ZEIGLER USC		
seed #12	ALAN GOETSCH, NORTHWESTERN COLLEGE	(52) EVENS,	8-1	
8		FALL 2:00		
36				SERNOWSKI SF
9	DENNIS POGUE, KEARNEY STATE COLLEGE			15-5
10	DENNIS COOK, WAYNESBURG COLLEGE	(53) COOK,	10-2	
11	GREG DIXON, FORT HAYS STATE UNIVERSITY	(163) SERNOWSKI SF		
seed #1	ED SERNOWSKI, SIMON FRASER UNIVERSITY	(54) SERNOWSKI,	Fall 2:37	
12		FALL 2:24		
40				(276) SERNOWSKI SF
13	BILL WELDER, MOORHEAD STATE UNIVERSITY			7-4
seed #8	BOB FREUND, PACIFIC LUTHERAN UNIVERSITY	(55) FREUND,	TK 20-3	
seed #9	BRAD CHRISTENSEN, SOUTHERN OREGON STATE	(164) CHRISTENSEN		CHRISTENSEN Sore
16	JAMES COOPER, DICKINSON STATE UNIVERSITY	(56) CHRISTENSEN	FALL 1:42	
33				
17	SCOTT BARKER, MESA COLLEGE			
18	BYE			
seed #2	KEVIN FREEMAN, CENTRAL STATE UNIVERSITY	(165) FREEMAN CSU		
20	TRACY BRAGG, WEST LIBERTY STATE COLLEGE	(57) FREEMAN,	17-7	
39		FALL 2:11		
seed #7	MARK DUBEY, U. OF WISCONSIN-PARKSIDE	(58) DUBEY,		(277) FREEMAN CSU
22	TIMM SACHARISON, SOUTHWEST STATE UNIV	OT 3-1		12-4
23	ROB OBERG, U. OF WISCONSIN-SUPERIOR	(166) DUBEY UWP		
seed #10	REAGAN KLING, OLIVET NAZARENE UNIVERSITY	(59) KLING,	Fall 5:28	
24		7-4		
34				FREEMAN CSU
25	DALE KIME, CEDARVILLE COLLEGE	(60) LIEUALLEN,		10-5
26	JON LIEUALLEN, PACIFIC UNIVERSITY	8-1		
seed #3	TIM BLATTER, WESTERN MONTANA COLLEGE	(167) BLATTER WMC		
28	KIRK ALIRE, FORT LEWIS COLLEGE	(61) BLATTER,	11-2	
38		14-5		
seed #6	DAN CARLSON, NORTHERN MONTANA COLLEGE	(168) CARLSON N Mont		(278) BLATTER WMC
30	JIM LELWICA, U. OF MINNESOTA-DULUTH	7-3		OT 4-0
seed #11	ERIC BJORKLUND, U. OF MINNESOTA-MORRIS	(169) BJORKLUND,	6-3	
32	BYE			
35				



Champion

150
Weight

31st NAIA Wrestling Championships

Pacific Lutheran University Tacoma, Washington

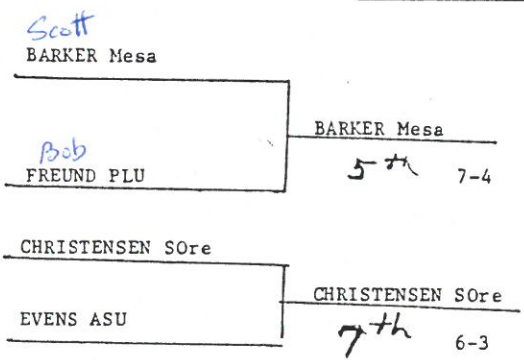
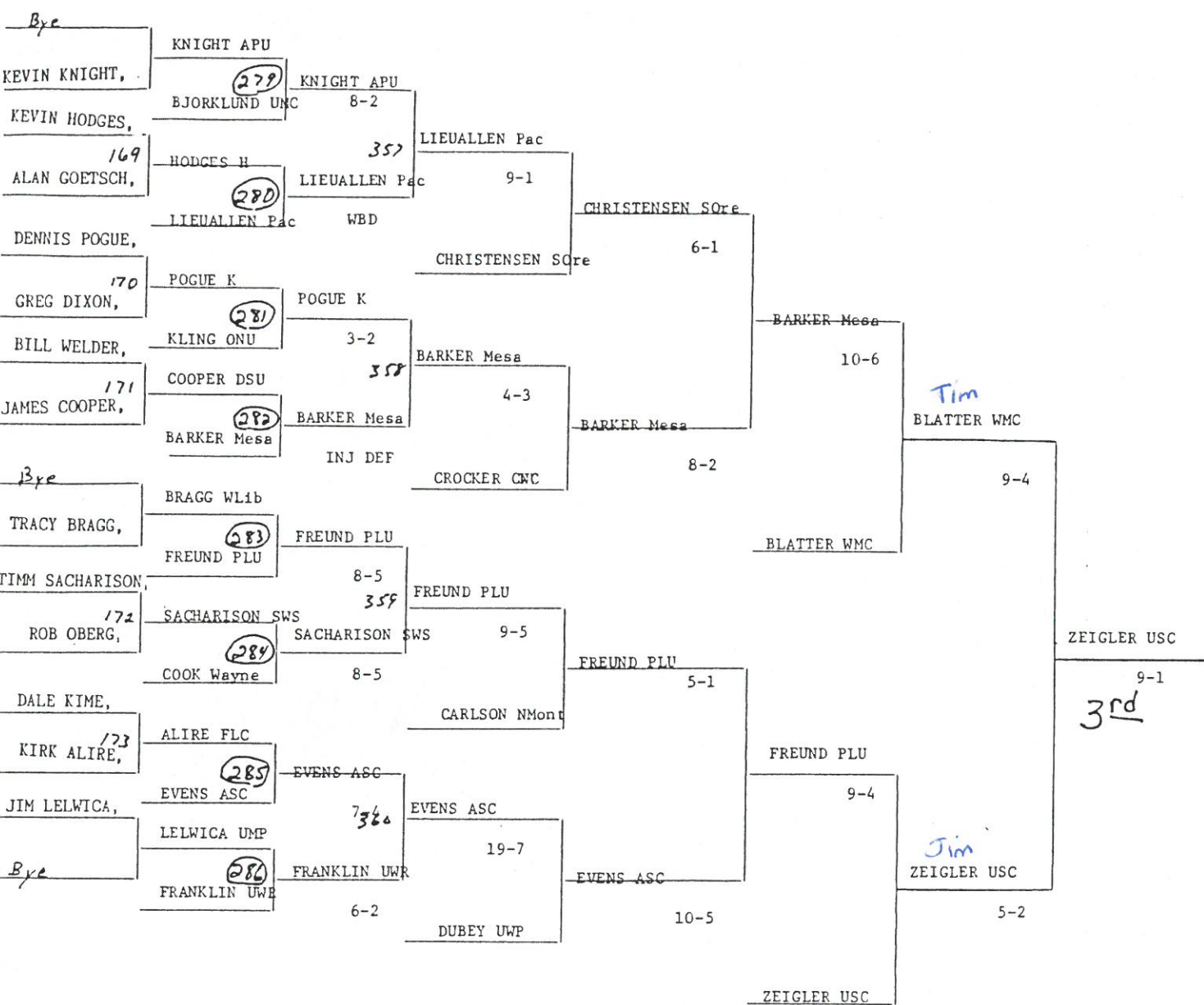

150
Consolation Bracket

31st NAIA Wrestling Championships

March 3, 4, 5, 1988 Pacific Lutheran University Tacoma, Washington

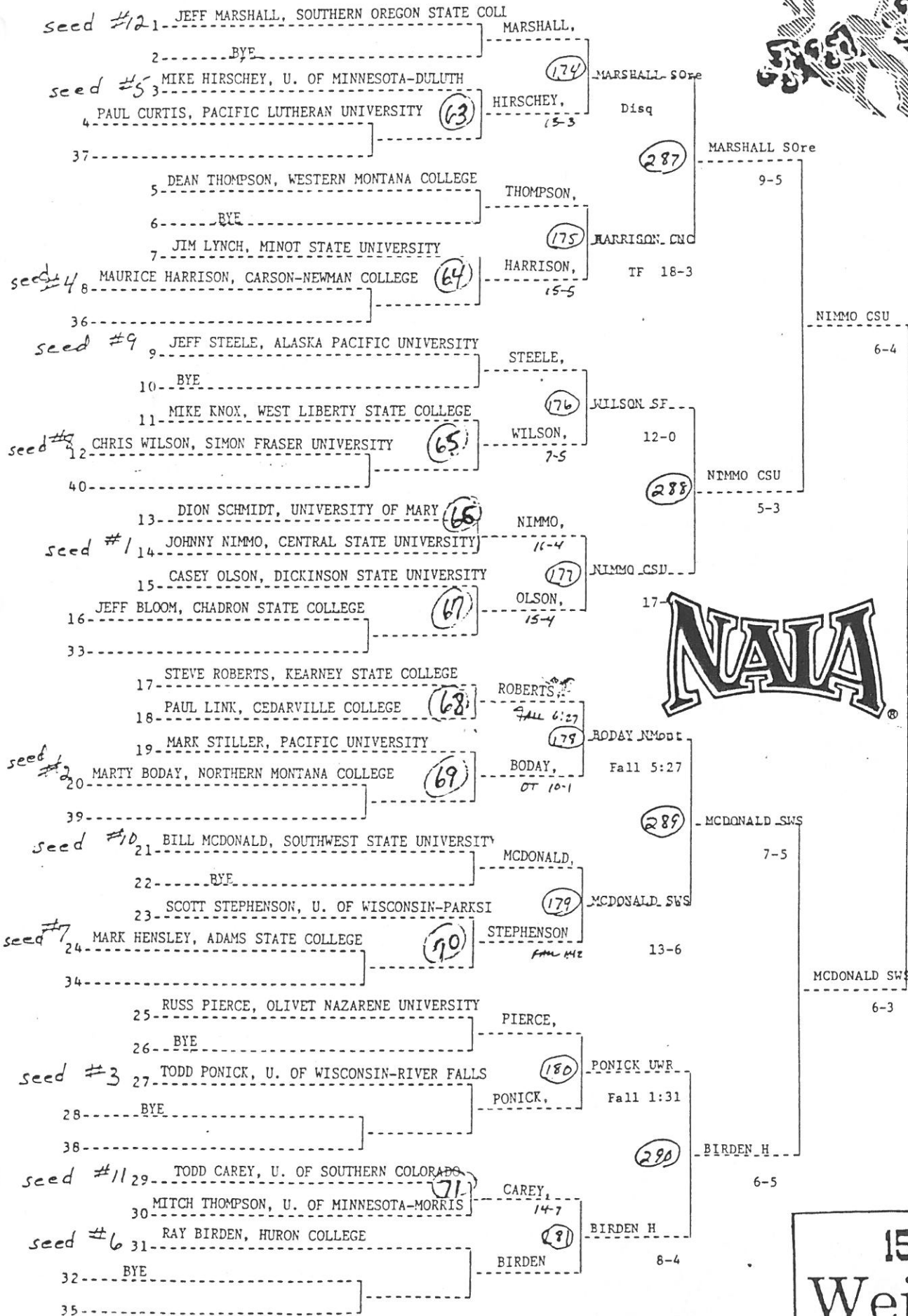

Champion

158
Weight

31st NAIA Wrestling Championships

Pacific Lutheran University Tacoma, Washington

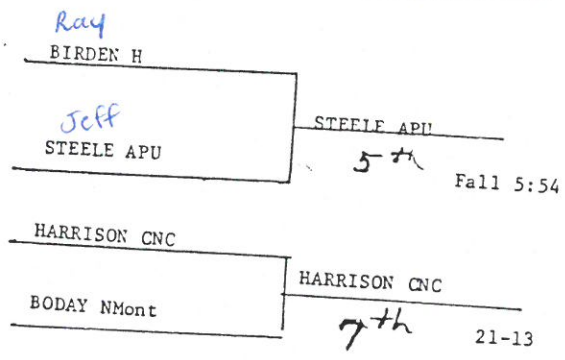
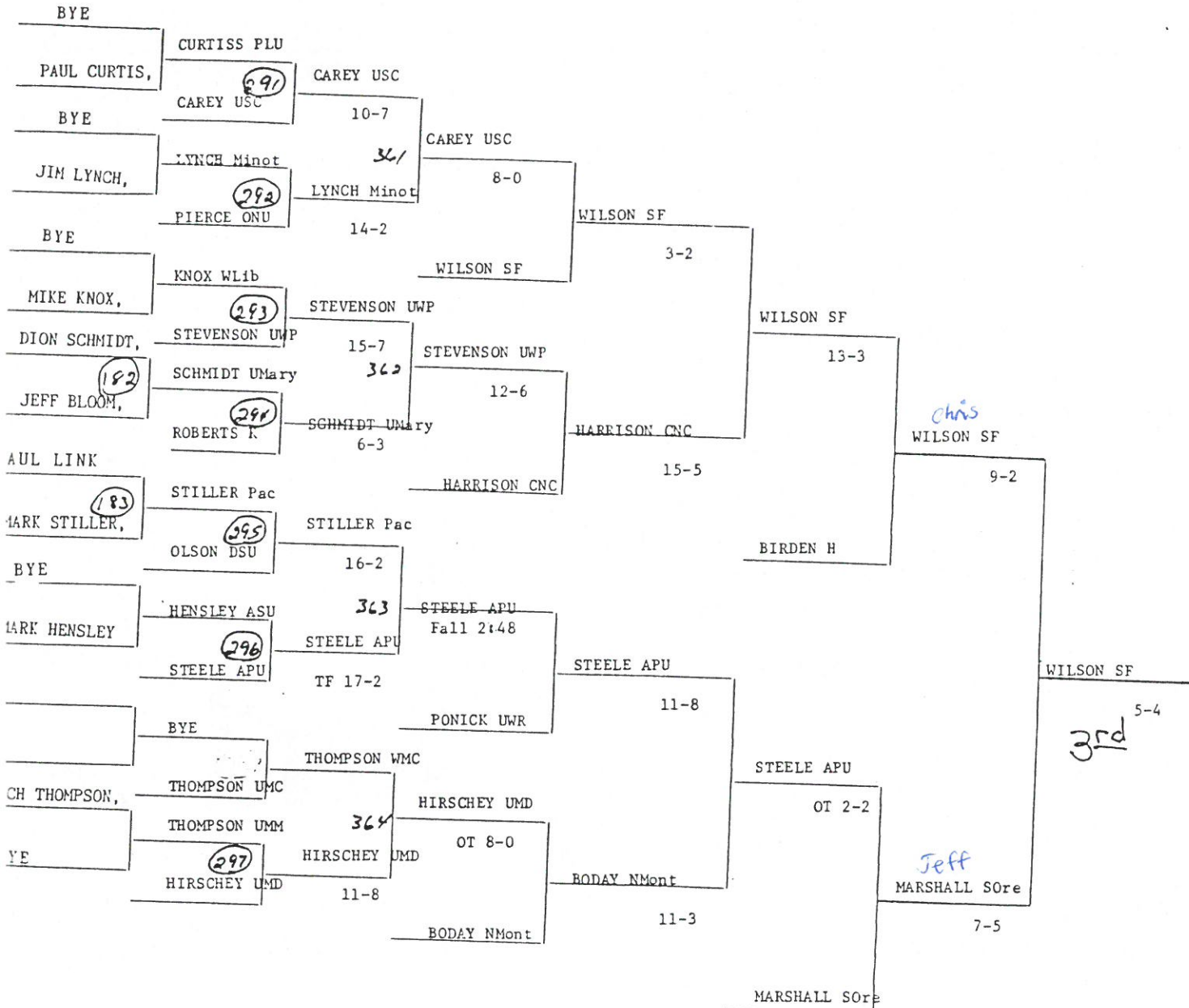

158

Consolation Bracket

31st NAIA Wrestling Championships

March 3, 4, 5, 1988 Pacific Lutheran University Tacoma, Washington

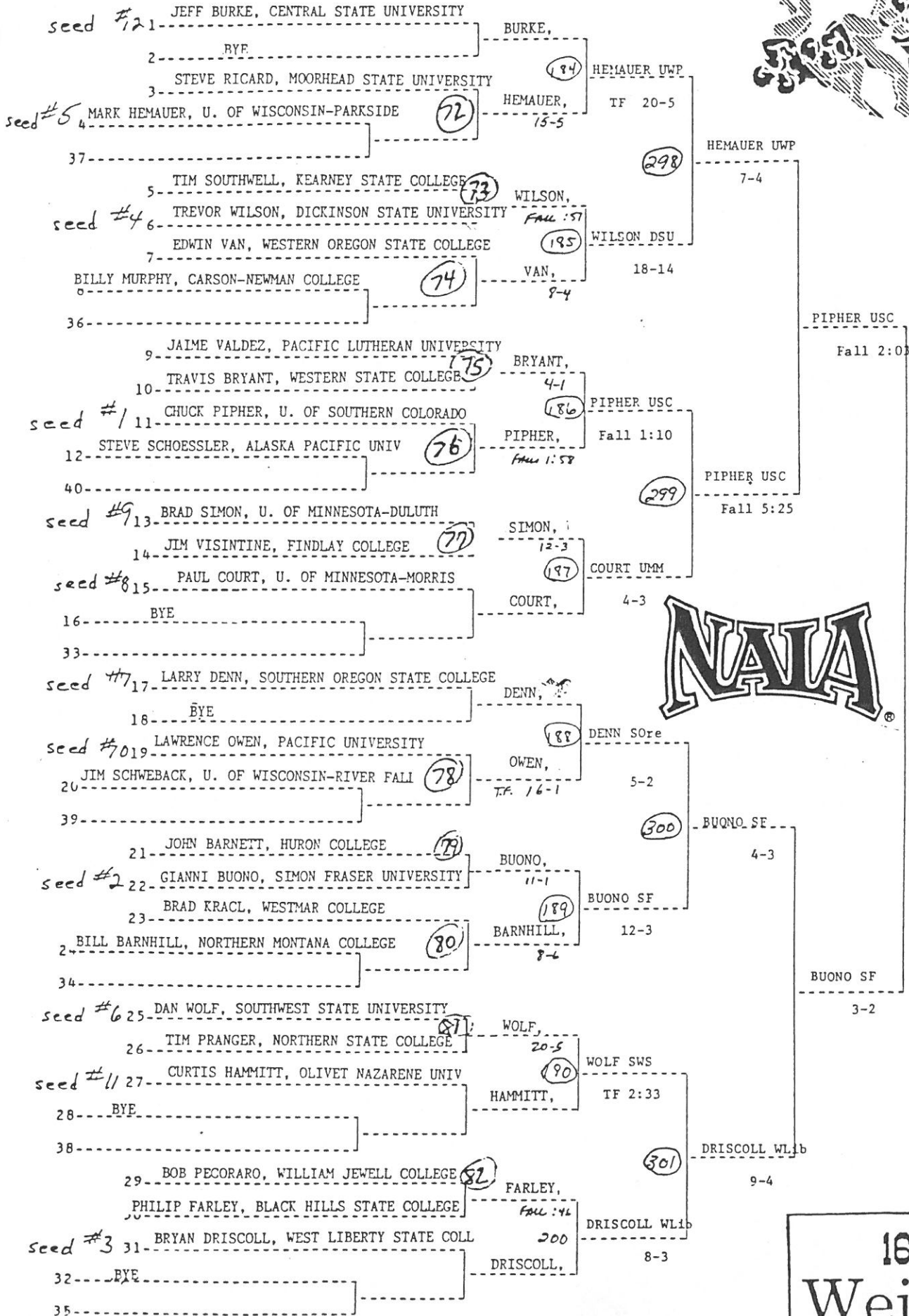

Champion

167
Weight

31st NAIA Wrestling Championships

Pacific Lutheran University Tacoma, Washington

BYE

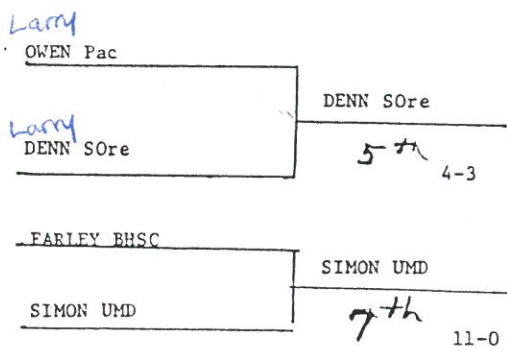
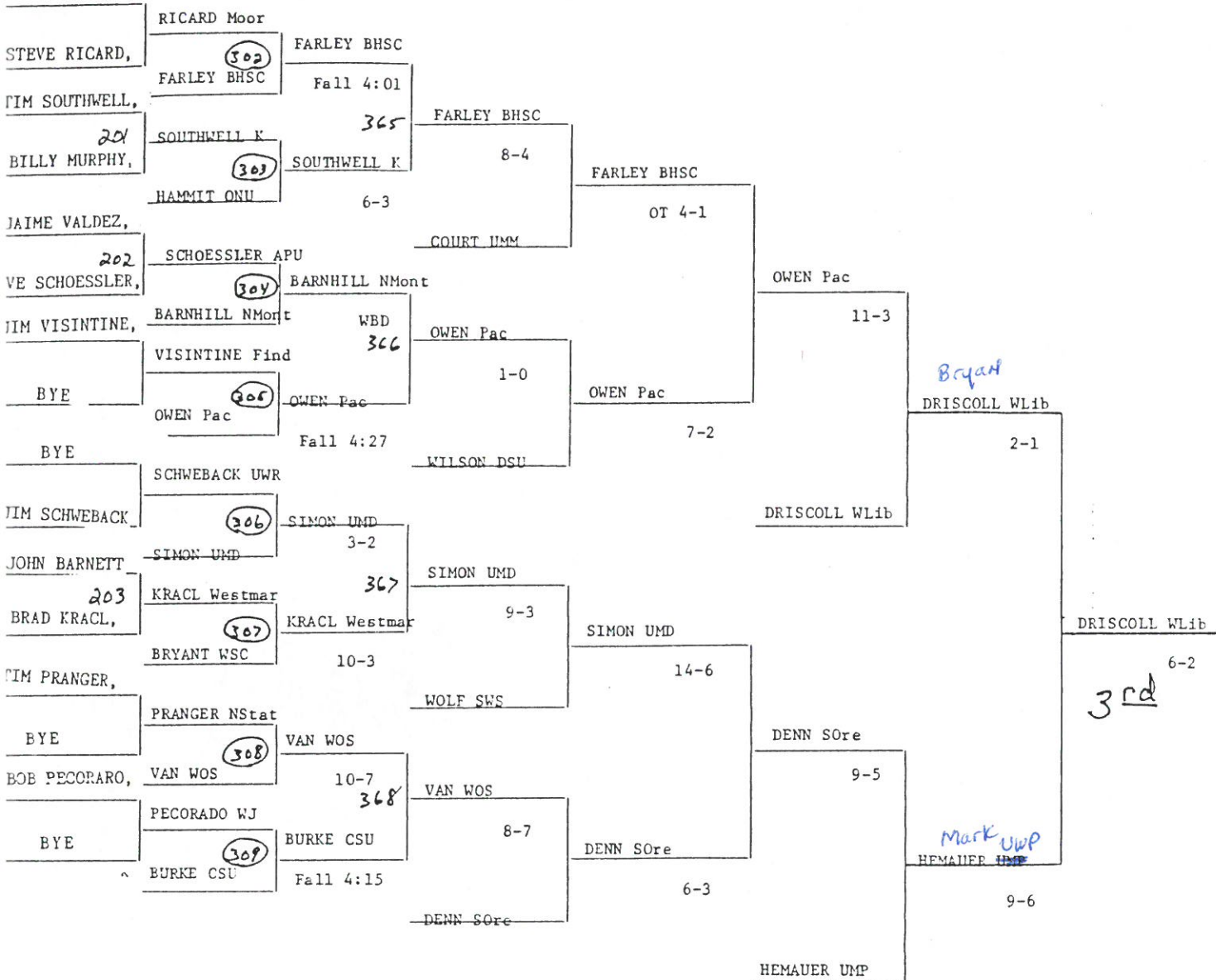

31st NAIA Wrestling Championships

March 3, 4, 5, 1988 Pacific Lutheran University Tacoma, Washington

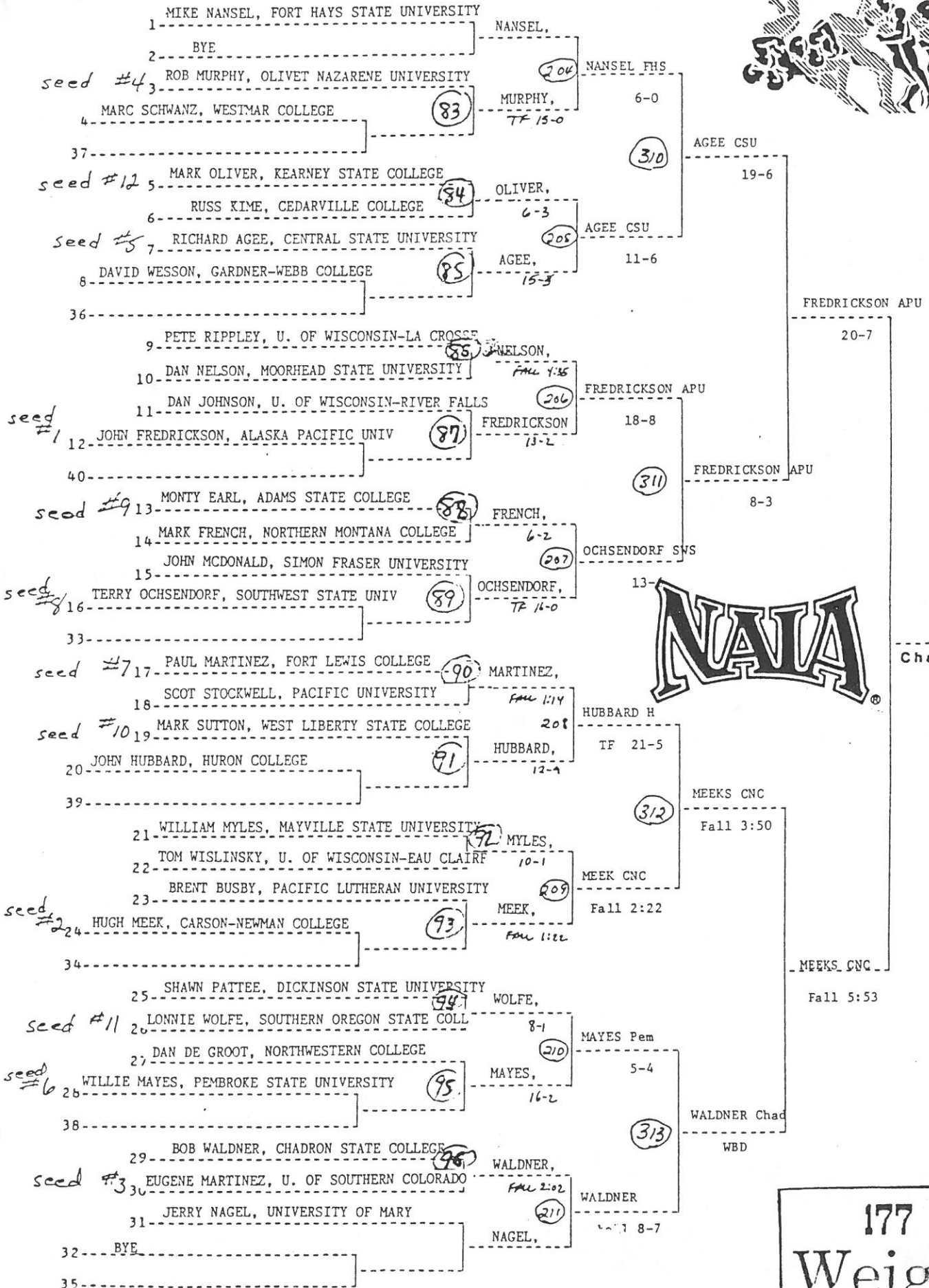

Champion

177
Weight.

31st NAIA Wrestling Championships

Pacific Lutheran University Tacoma, Washington

BYE

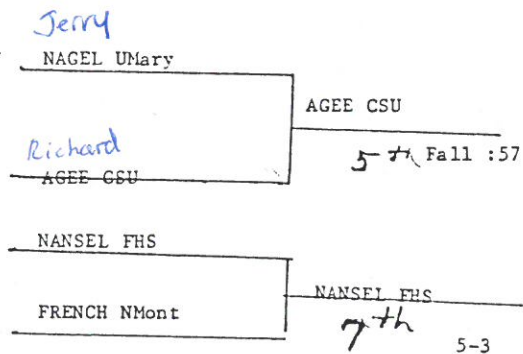
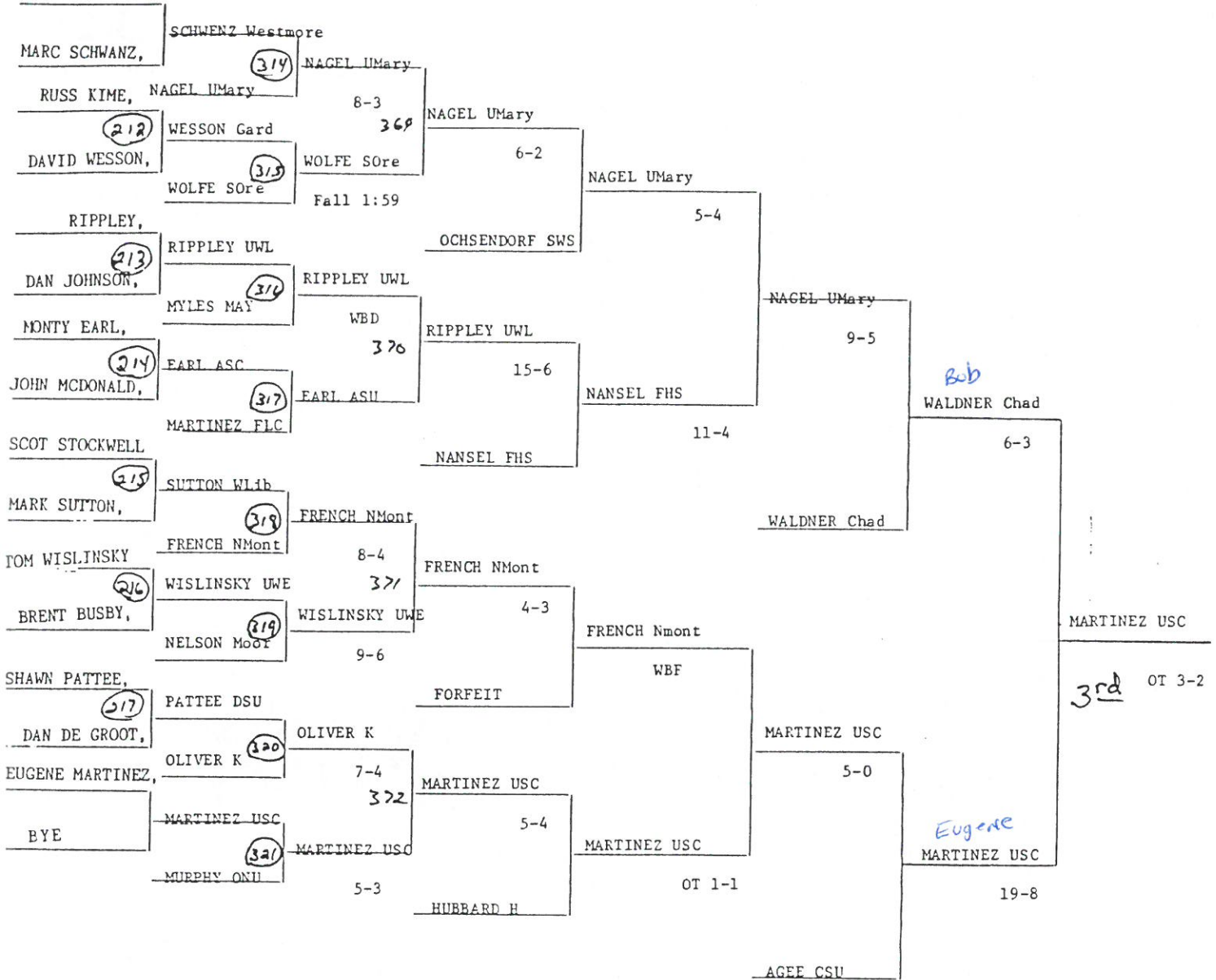

31st NAIA Wrestling Championships

March 3, 4, 5, 1988 Pacific Lutheran University Tacoma, Washington



seed #5	1 TOM UPCHURCH, ALASKA PACIFIC UNIVERSITY	UPCHURCH,		
	2 BYE		(218)	UPCHURCH APU
seed #123	3 NATHAN BRYANT, WESTERN STATE COLLEGE	BRYANT,		TF 18-2
	4 BYE			
	37			(222) MANVILLE ONU
	5 JIM SPOLEK, OREGON INSTITUTE OF TECH	SPOLEK,		8-7
	6 BYE			
	7 MIKE SCHAUER, MAYVILLE STATE UNIVERSITY	SCHAUER,	(219)	MANVILLE ONU
seed #4	8 BOB MANVILLE, OLIVET NAZARENE UNIVERSITY	MANVILLE,	(97)	Fall 4:46
	36		13-1	
seed #8	9 TODD CHERNEY, U. OF WISCONSIN-RIVER FALLS	CHERNEY,	(88)	OT 6-2
	10 MITCH BURGESS, NORTHERN MONTANA COLLEGE	BURGESS,	12-4	
seed #9	11 STEVE UTESCH, WESTMAR COLLEGE	UTESCH,	(220)	CHERNEY UMR
	12 BYE			3-0
	40			(223) COLVIN USC
seed #1	13 CHUCK MICHAELSON, DICKINSON STATE UNIV	MICHAELSON,	(79)	8-7
	14 KEVIN COLVIN, U. OF SOUTHERN COLORADO	COLVIN,	8-2	COLVIN USC
	15 GARRETT GILBERT, PACIFIC LUTHERAN UNIV	GILBERT,	(221)	Fall :40
	16 BYE			
	33			
	17 BILL PRICE, KEARNEY STATE COLLEGE	PRICE,		
	18 BYE			
seed #2	19 PAUL NEUNER, CARSON-NEWMAN COLLEGE	NEUNER,	(222)	WOZNIAK UWE
	20 BOB WOZNIAK, U. OF WISCONSIN-EAU CLAIRE	WOZNIAK,	(100)	10-4
	39			OT 5-0
seed #7	21 ROGER RAHM, HURON COLLEGE	RAHM,		(324) WOZNIAK UWE
	22 BYE			8-7
seed #10	23 SCOTT BIANCO, SIMON FRASER UNIVERSITY	BIANCO,	(223)	BIANCO SP
	24 BYE			12-4
	34			
seed #6	25 JIM NICHOLL, SOUTHERN OREGON STATE COLLEGE	NICHOLL,		PICKETT Mesa
	26 SIDNEY LACKEY, GARDNER-WEBB COLLEGE	LACKEY,	(101)	OT 2-0
			FALL 2:31	
seed #112	27 DAN STIFTER, U. OF MINNESOTA-MORRIS	STIFTER,	(224)	NICHOLL SORe
	28 BYE			7-3
	38			
seed #3	29 SCOTT PICKERT, MESA COLLEGE	PICKERT,		(325) PICKERT Mesa
	30 BYE			8-4
	31 WILLIE SCHUMACHER, NORTHERN STATE COLLEGE	SCHUMACHER,	(225)	PICKERT Mesa
	32 BYE			TF 15-0
	35			



Champion

190
Weight

31st NAIA Wrestling Championships

March 3, 4, 5, 1988 Pacific Lutheran University Tacoma, Washington



Seed #	Name	College	Weight	Opponent	Result	Score
1	JEFF RUSSELL	MESA COLLEGE	217	RUSSELL, Mesa	Fall 2:53	330
2	BYE					
3	DARIN DOLLEMORE	PACIFIC LUTHERAN UNIV	102	WARNER, Fall 2:15		
4	ROB WARNER	NORTHERN MONTANA COLLEGE				
5	JOHN RICHBURG	ADAMS STATE COLLEGE	218	RICHBURG, ASC	DISQ	
6	BYE					
7	KEN FOUTS	NORTHERN STATE COLLEGE	103	FOUTS, OT 1-1		
8	MARTIN NOWKA	PACIFIC UNIVERSITY				
9	LARRY GRIEVE	U. OF SOUTHERN COLORADO	219	GRIEVE, USC	8-2	
10	MIKE FORRESTER	OREGON INSTITUTE OF TECH	104	FALL 1:22		
11	PAUL PERRINE	FINDLAY COLLEGE	105	HUGHES, 7-6		
12	SHAWN HUGHES	ALASKA PACIFIC UNIVERSITY				
13	KEITH TURNER	U. OF WISCONSIN-SUPERIOR	106	PAYNE, FALL 1:02		
14	DAN PAYNE	SIMON FRASER UNIVERSITY				
15	WES THOMPSON	CARSON-NEWMAN COLLEGE	220	PAYNE SF, Fall 6:1		
16	BYE					
17	JOHN JANECEK	KEARNEY STATE COLLEGE	221	WILLIAMSON UMM, TF 19-3		
18	BYE					
19	JIM WILLIAMSON	U. OF MINNESOTA-MORRIS	107	WILLIAMSON, TF 17-1		
20	PAUL SLATER	DANA COLLEGE				
21	BOB WASKOW	OLIVET NAZARENE UNIVERSITY	222	ALLEY, Sore		
22	J.D. ALLEY	SOUTHERN OREGON STATE COLLEGE	108	FALL 5:08		
23	CURTIS RILEY	CENTRAL STATE UNIVERSITY	109	WALKER, 4-3		
24	BILL WALKER	CENTRAL WASHINGTON UNIV				
25	MIKE MAX	CHADRON STATE COLLEGE	223	SCHRUPP, SWS, 5-4		
26	TIM SCHRUPP	SOUTHWEST STATE UNIVERSITY	110	FALL 1:15		
27	TIM LEUER	WESTMAR COLLEGE				
28	BYE					
29	FRED MAROSCHEK	MAYVILLE STATE UNIV	224	MAROSCHEK MAY, TF 17-0		
30	DAVID BALDWIN	GARDNER-WEBB COLLEGE	111	10-0		
31	BRIAN PEREZ	CEDARVILLE COLLEGE				
32	BYE					
33	BYE					

NAIA

Champion

275
Weight

31st NAIA Wrestling Championships

Pacific Lutheran University Tacoma, Washington

BYE

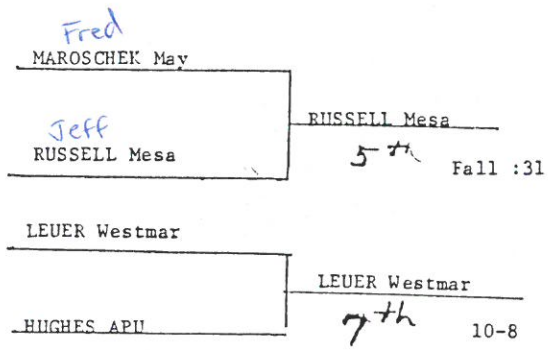
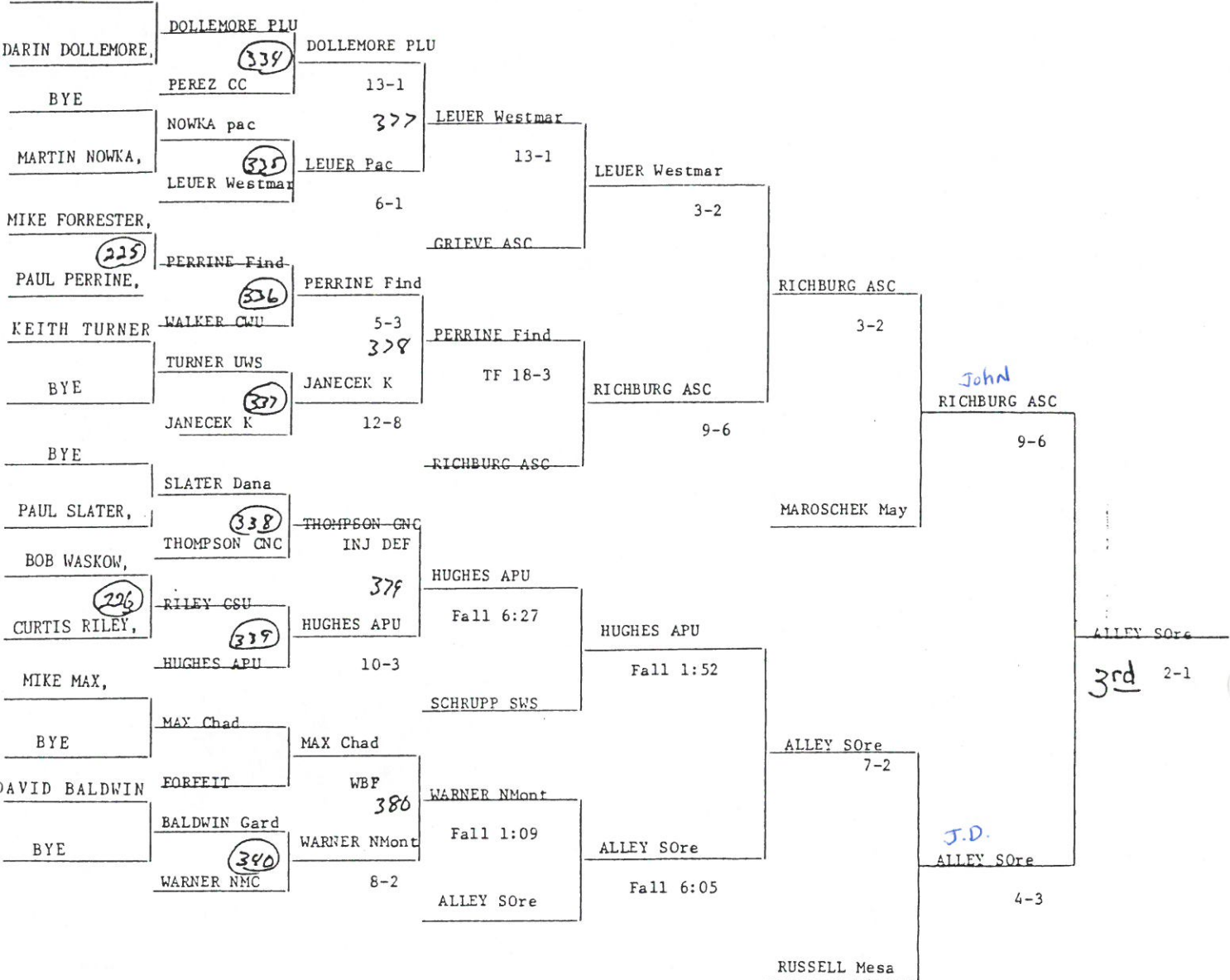

275

Consolation Bracket